

ZONING

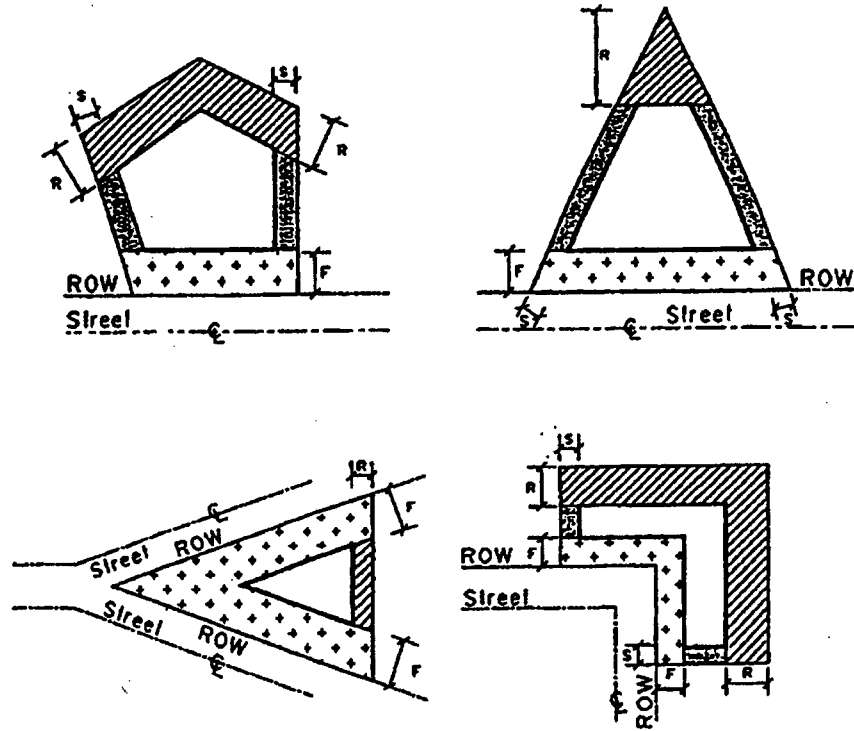



16 Attachment 4

Township of Greenwich

Yard Definition Diagrams





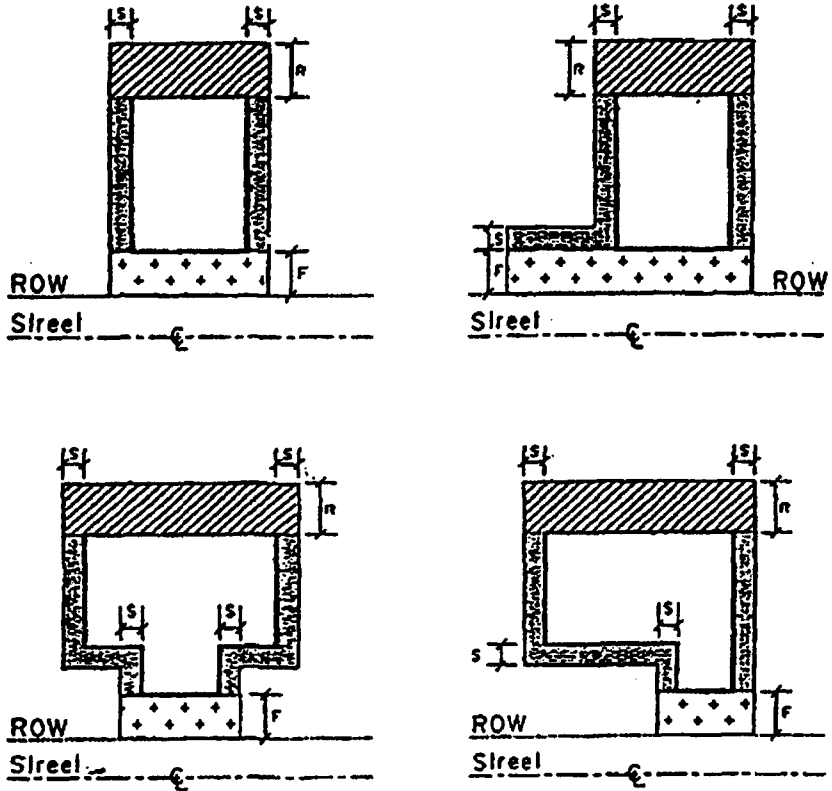

**LEGEND**

-  Front Yard = F
-  Side Yard = S
-  Rear Yard = R
-  Area within which building must be located (Building Envelope)

GREENWICH CODE





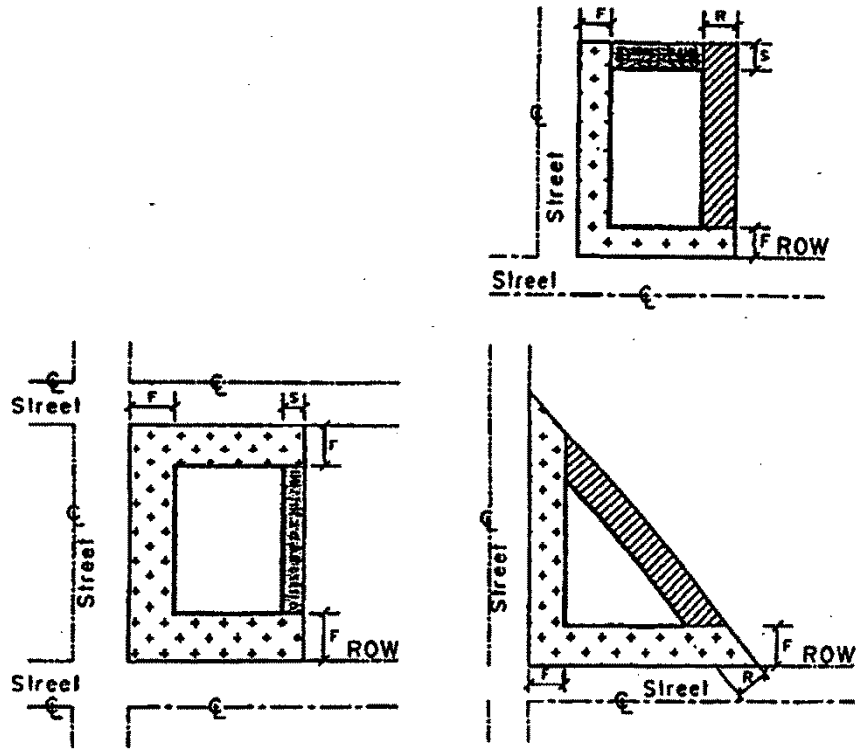

**LEGEND**

-  Front Yard = F
-  Side Yard = S
-  Rear Yard = R
-  Area within which building must be located (Building Envelope)

# ZONING



## LEGEND

-  Front Yard = F
-  Side Yard = S
-  Rear Yard = R
-  Area within which building must be located (Building Envelope)