

ZONING

27 Attachment 2

Borough of Mechanicsburg

Parking Diagrams and Street Sections/Exhibits

[Added by Ord. 1139, 7/15/2014]

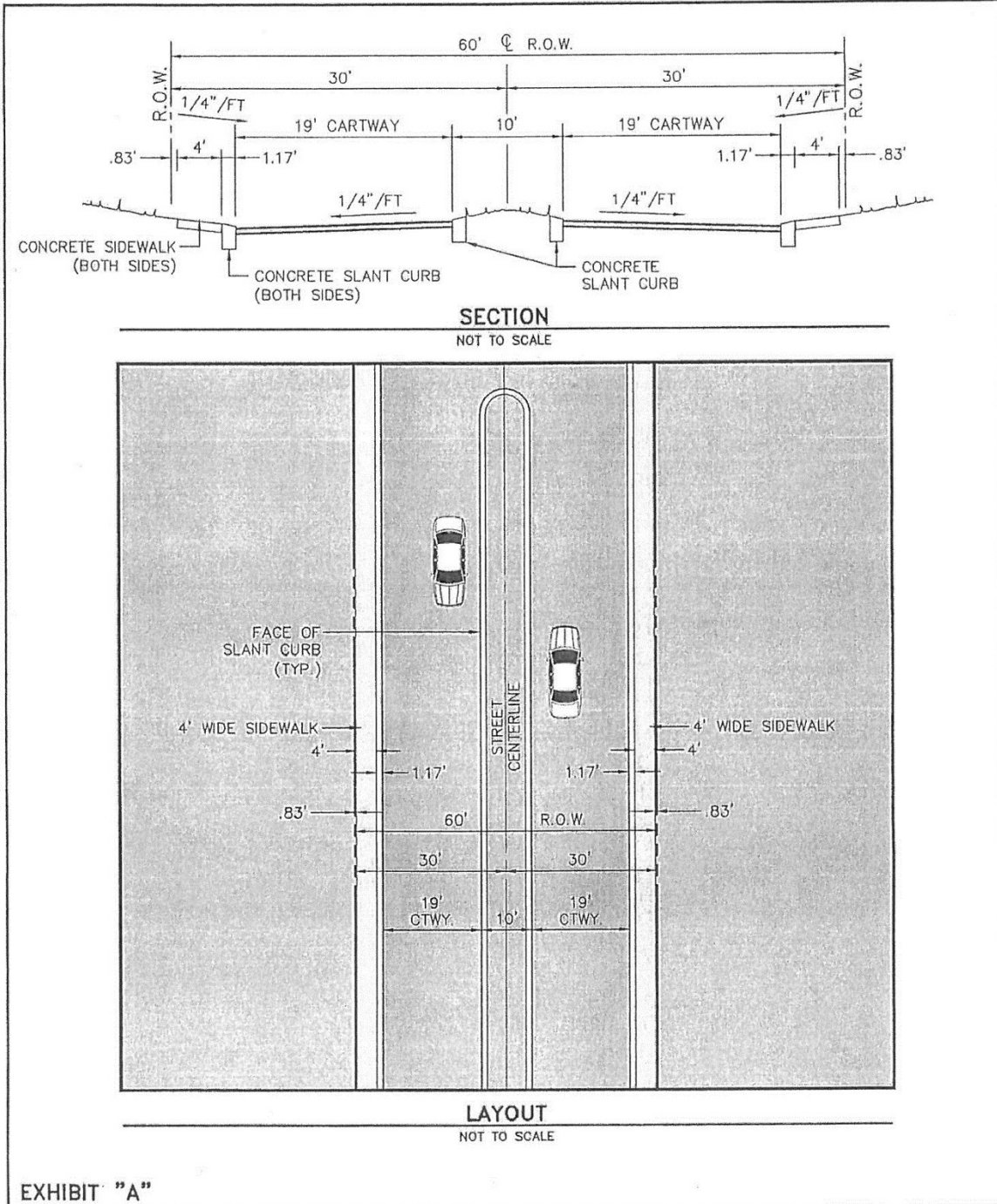

<p>10' WIDE BOULEVARD – NO ON-STREET PARKING FOR MECHANICSBURG TND MECHANICSBURG BORO CUMBERLAND COUNTY, PA</p>	<p>PIONEER Management, LLC <small>111 Wierysville Road, Lancaster, PA 17603 Phone (717) 481-5500 • Fax (717) 481-4955 Email: j1@pioneermanagementllc.com Website: www.pioneermanagementllc.com</small></p>	<p>DRAWN BY: <u>DAF</u> DATE: <u>APRIL 2, 2014</u> SCALE: <u>NOT TO SCALE</u> DWG. NO. <u>11-0950-01-A</u></p>
---	---	--

MECHANICSBURG CODE

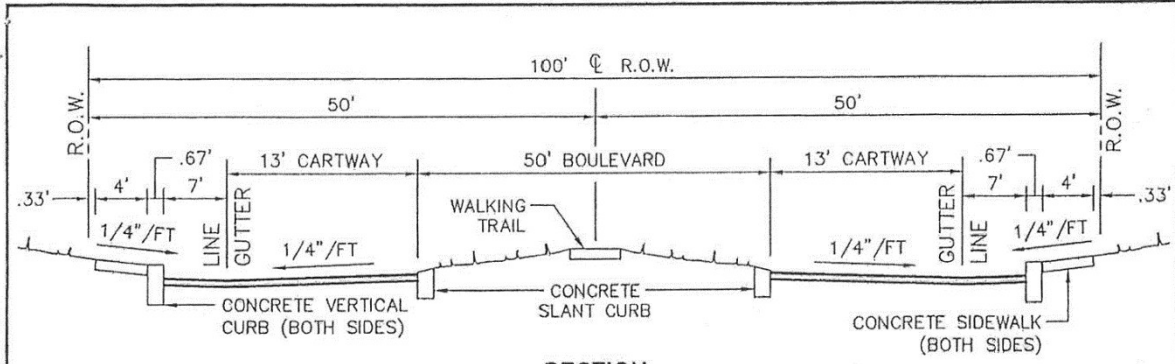

SECTION

NOT TO SCALE

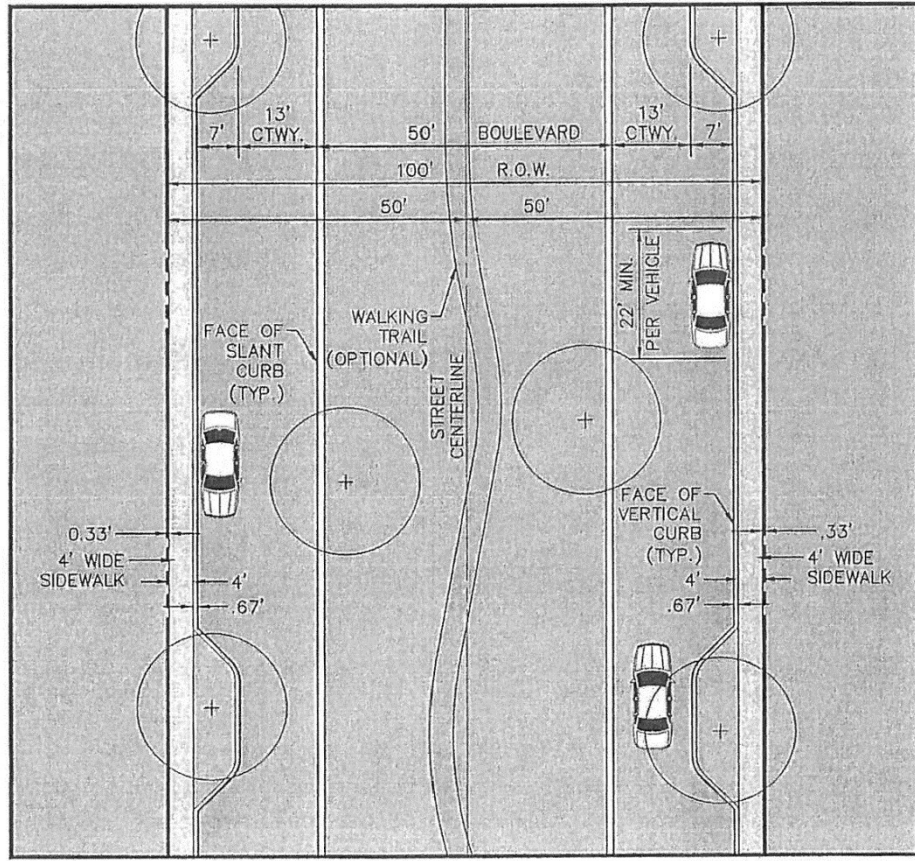

LAYOUT

NOT TO SCALE

EXHIBIT "B"

50' WIDE BOULEVARD –
ON-STREET PARKING (BOTH SIDES)
FOR
MECHANICSBURG TND
MECHANICSBURG BORO CUMBERLAND COUNTY, PA

PIONEER
Management, LLC

111 Ultraprairie Road, Lancaster, PA 17603
Phone: (717) 461-5200 • Fax: (717) 461-4955
Email: j@pioneermanagementllc.com
Webpage: www.pioneermanagementllc.com

DRAWN BY: DAF
DATE: APRIL 2, 2014
SCALE: NOT TO SCALE
DWG. NO. 11-0950-01-A

ZONING

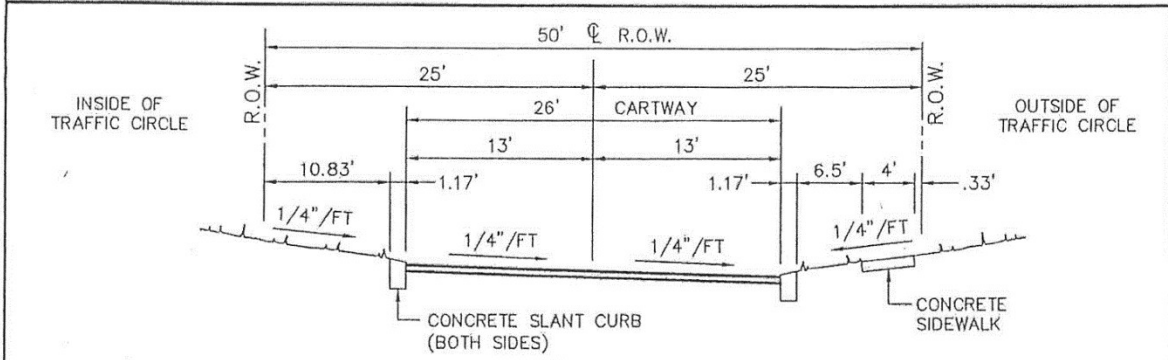

SECTION
NOT TO SCALE

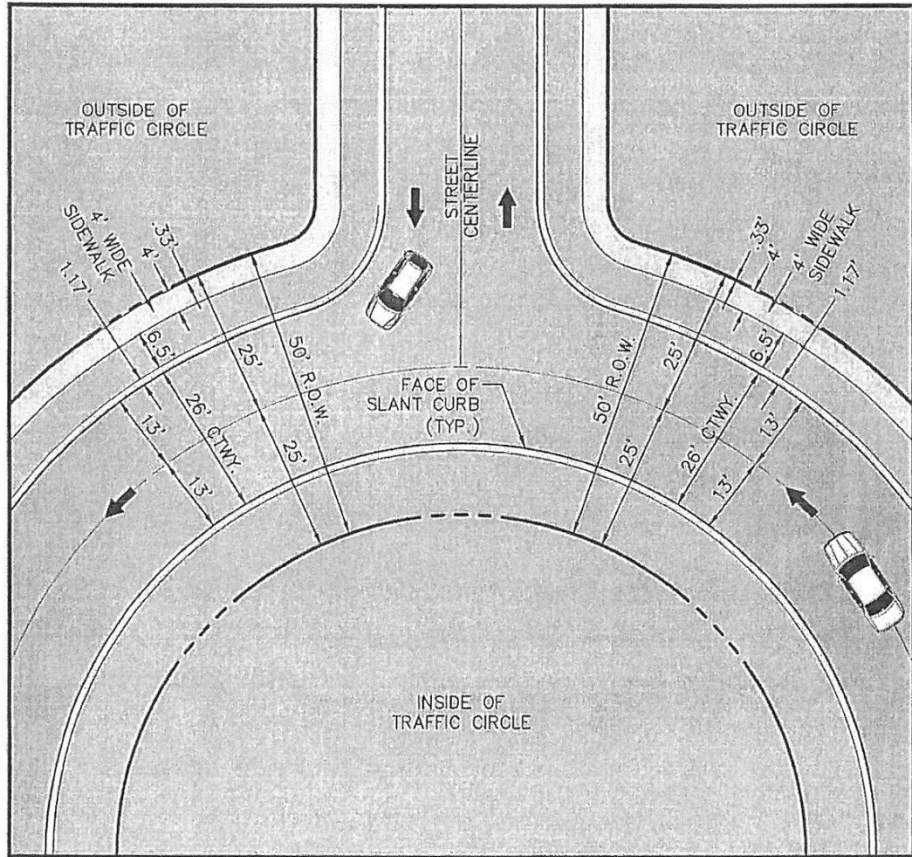

LAYOUT
NOT TO SCALE

<p>EXHIBIT "C"</p> <p>ONE-WAY TRAFFIC CIRCLE AT INTERSECTIONS FOR MECHANICSBURG TND MECHANICSBURG BORO CUMBERLAND COUNTY, PA</p>	<p>PIONEER Management, LLC</p> <p>111 Millersville Road, Lancaster, PA 17603 Phone (717) 481-2500 • Fax (717) 481-4955 Email: j@pioneermanagementllc.com Website: www.pioneermanagementllc.com</p>	<p>DRAWN BY: <u>DAF</u></p> <p>DATE: <u>APRIL 2, 2014</u></p> <p>SCALE: <u>NOT TO SCALE</u></p> <p>DWG. NO. <u>11-0950-01-A</u></p>
--	---	---

MECHANICSBURG CODE

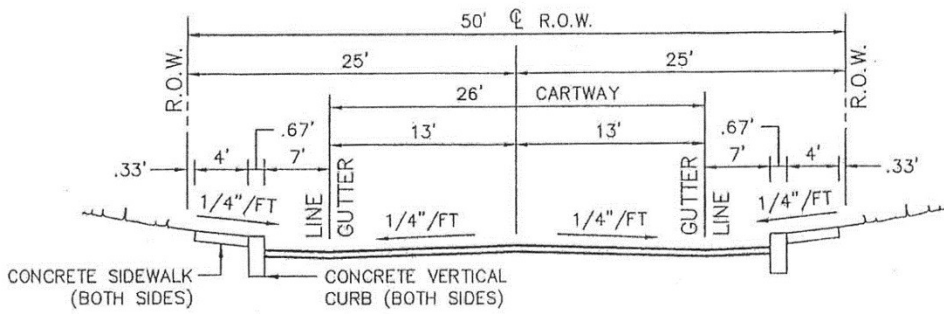

SECTION

NOT TO SCALE

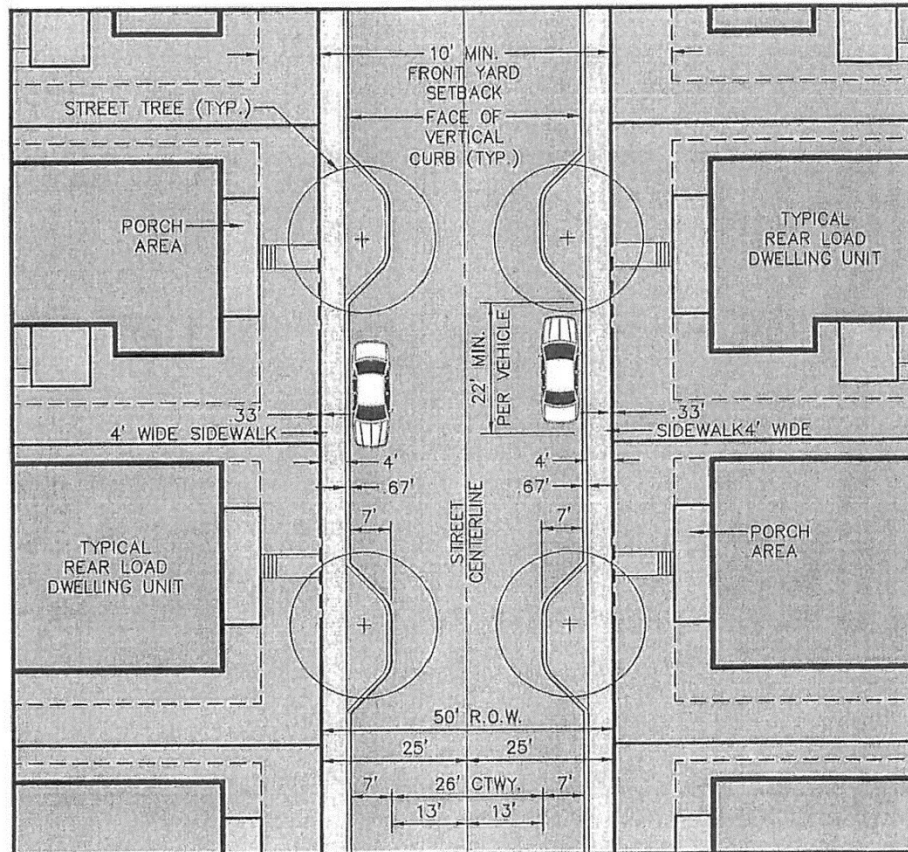

LAYOUT

NOT TO SCALE

EXHIBIT "D"

TYPICAL STREETScape -
ON-STREET PARKING (BOTH SIDES)
FOR

MECHANICSBURG TND

MECHANICSBURG BORO CUMBERLAND COUNTY, PA

PIONEER
Management, LLC

111 Millersville Road, Lancaster, PA, 17603
Phone: (717) 461-5200 • Fax: (717) 461-4955
Email: j@pioneermanagementllc.com
Website: www.pioneermanagementllc.com

DRAWN BY: DAF

DATE: APRIL 2, 2014

SCALE: NOT TO SCALE

DWG. NO. 11-0950-01-A

ZONING

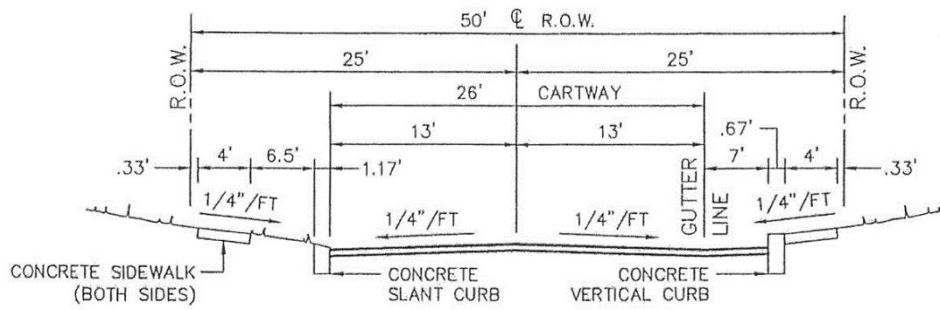

SECTION

NOT TO SCALE

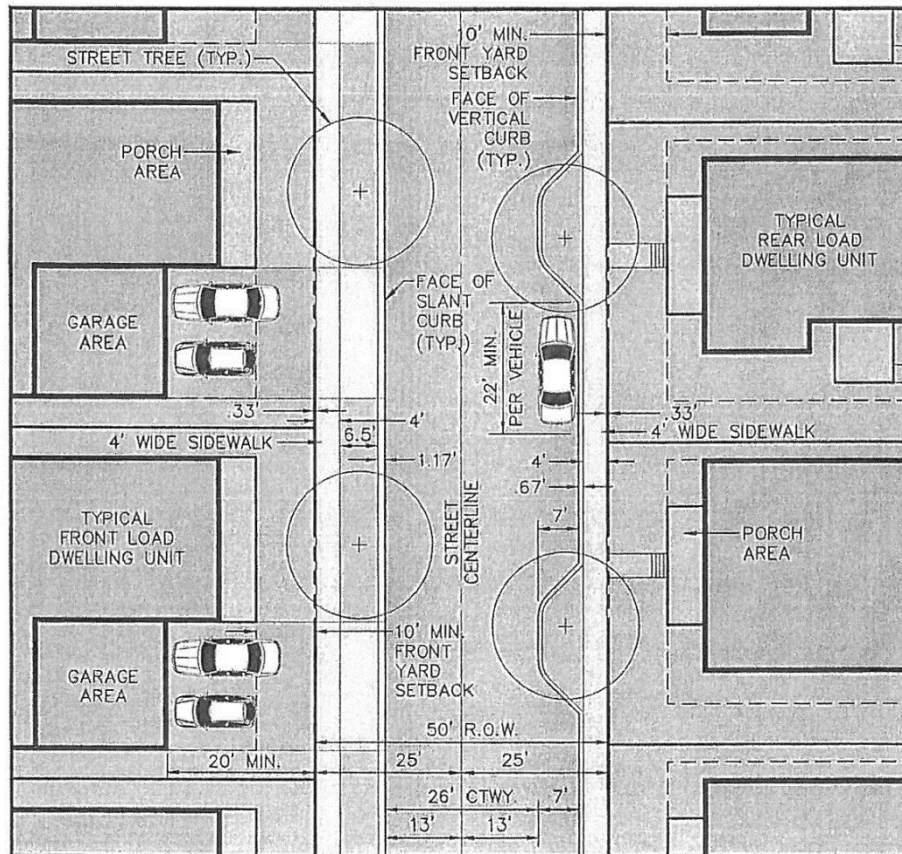

LAYOUT

NOT TO SCALE

EXHIBIT "E"

TYPICAL STREETScape - ON-STREET
 PARKING (ONE SIDE) (STYLE 1)

FOR
MECHANICSBURG TND

MECHANICSBURG BORO CUMBERLAND COUNTY, PA

PIONEER
 Management, LLC

111 Millersville Road, Lonsdale, PA 17603
 Phone (717) 481-5000 • Fax (717) 481-4955
 Email: info@pioneermanagementllc.com
 Webpage: www.pioneermanagementllc.com

DRAWN BY: DAF

DATE: APRIL 2, 2014

SCALE: NOT TO SCALE

DWG. NO. 11-0950-01-A

MECHANICSBURG CODE

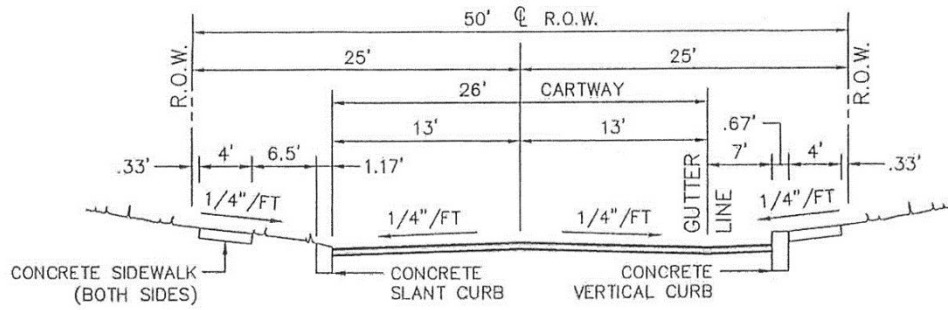

SECTION

NOT TO SCALE

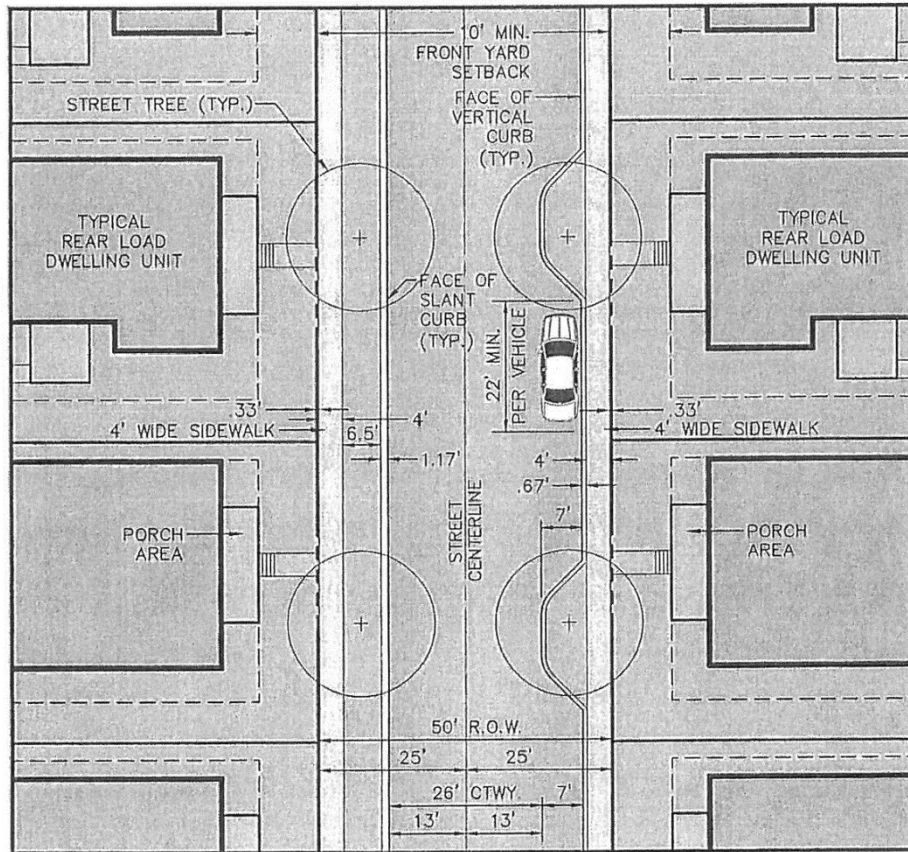

LAYOUT

NOT TO SCALE

EXHIBIT "F"

TYPICAL STREETSCAPE - ON-STREET
PARKING (ONE SIDE) (STYLE 2)

FOR
MECHANICSBURG TND

MECHANICSBURG BORO CUMBERLAND COUNTY, PA

PIONEER
Management, LLC

111 Milesville Road, Lancaster, PA 17603
Phone (717) 461-2500 • Fax (717) 461-4955
Email: info@pioneermanagementllc.com
Website: www.pioneermanagementllc.com

DRAWN BY: DAF
DATE: APRIL 2, 2014
SCALE: NOT TO SCALE
DWG. NO. 11-0950-01-A

MECHANICSBURG CODE

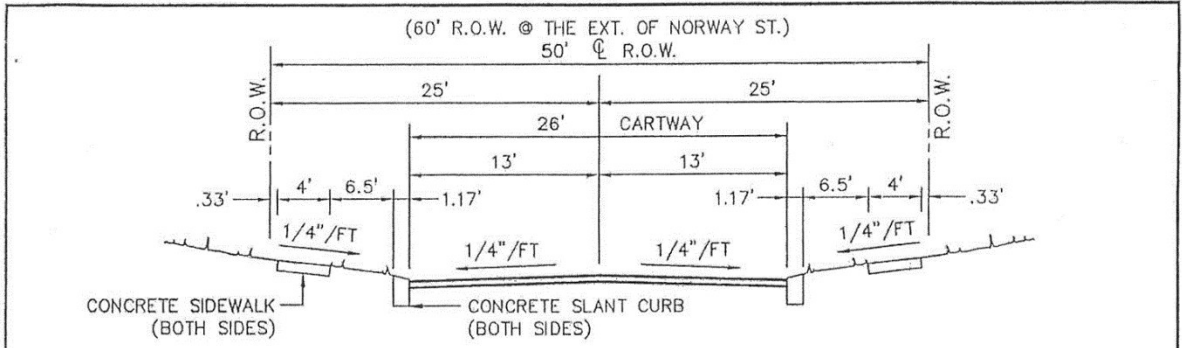

SECTION

NOT TO SCALE

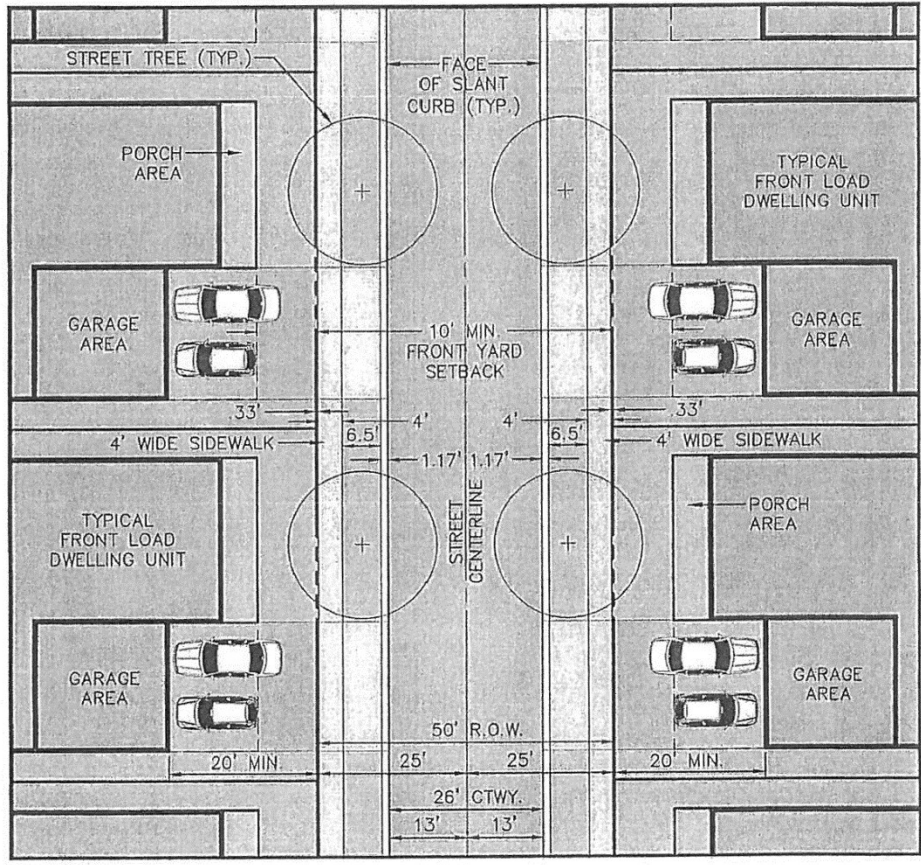

LAYOUT

NOT TO SCALE

EXHIBIT "H"

TYPICAL STREETScape -
NO ON-STREET PARKING
FOR
MECHANICSBURG TND

MECHANICSBURG BORO

CUMBERLAND COUNTY, PA

PIONEER
Management, LLC

111 Millersville Road, Lancaster, PA 17603
Phone (717) 481-5500 • Fax (717) 481-4955
Email: info@pioneermanagementllc.com
Website: www.pioneermanagementllc.com

DRAWN BY: DAF
DATE: APRIL 2, 2014
SCALE: NOT TO SCALE
DWG. NO. 11-0950-01-A

ZONING

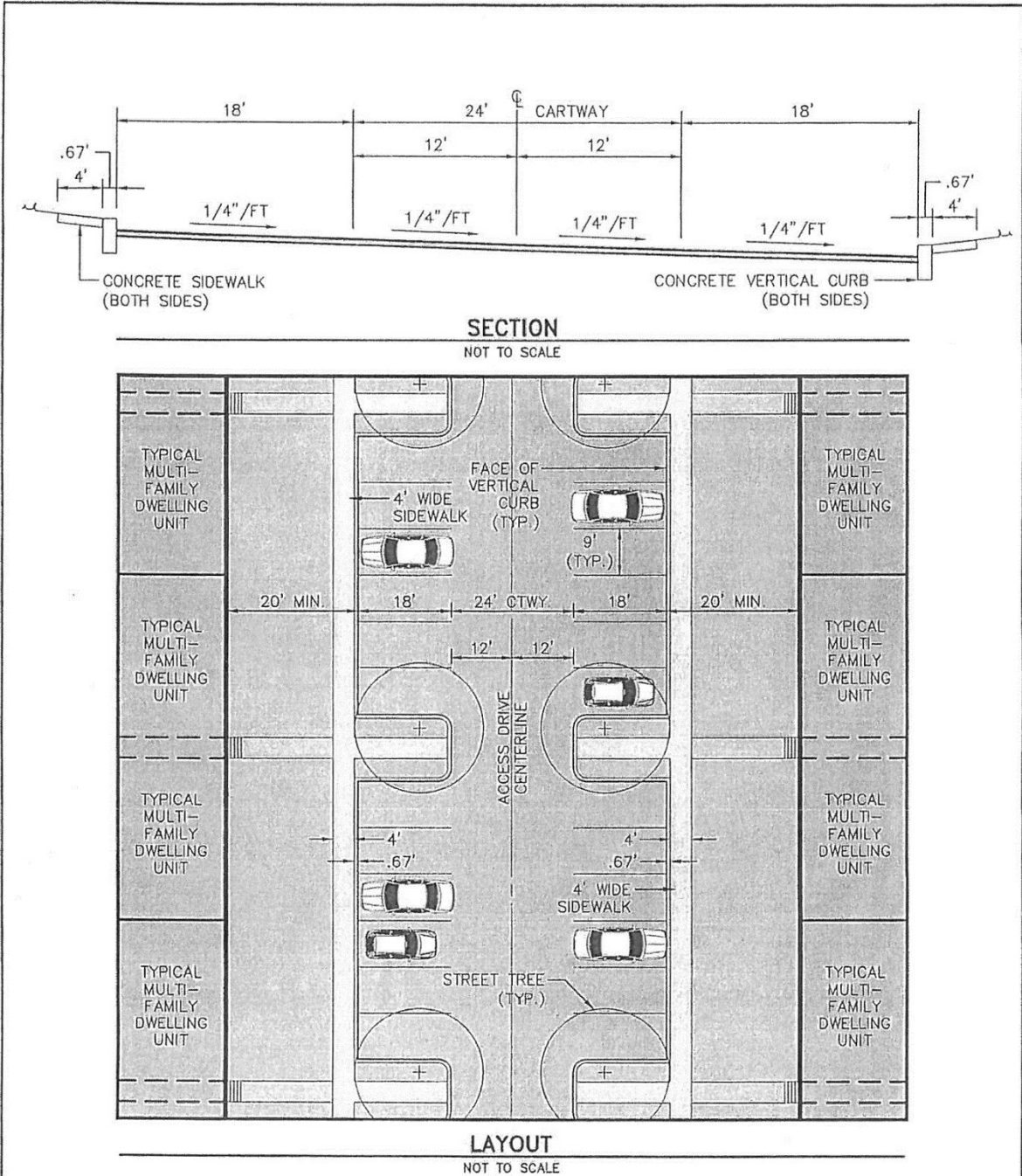

EXHIBIT "I"

<p>ACCESS DRIVE WITH PERPENDICULAR PARKING FOR MECHANICSBURG TND MECHANICSBURG BORO CUMBERLAND COUNTY, PA</p>	<p>PIONEER Management, LLC <small>111 Ultrasite Road, Lancaster, PA 17603 Phone (717) 481-5500 • Fax (717) 481-4955 Email: jhd@pioneermanagementllc.com Webpage: www.pioneermanagementllc.com</small></p>	<p>DRAWN BY: <u>DAF</u> DATE: <u>APRIL 2, 2014</u> SCALE: <u>NOT TO SCALE</u> DWG. NO. <u>11-0950-01-A</u></p>
--	--	--

MECHANICSBURG CODE

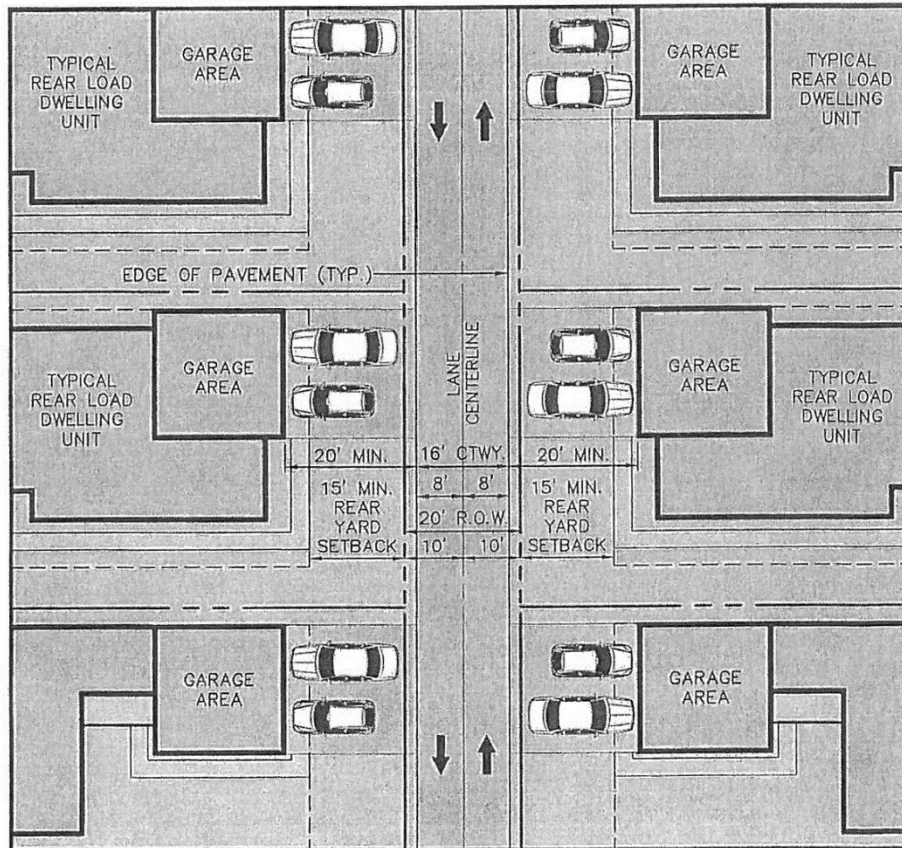
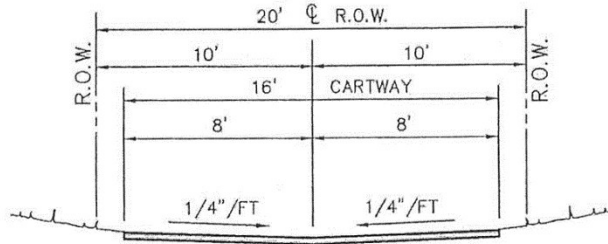

EXHIBIT "J"

TYPICAL TWO-WAY LANE —
NO ON-STREET PARKING
FOR
MECHANICSBURG TND

MECHANICSBURG BORO CUMBERLAND COUNTY, PA

PIONEER
Management, LLC

111 Millersville Road, Lancaster, PA 17603
Phone: (717) 401-2500 • Fax: (717) 401-4925
Email: jl@pioneermanagementllc.com
Website: www.pioneermanagementllc.com

DRAWN BY: DAF

DATE: APRIL 2, 2014

SCALE: NOT TO SCALE

DWG. NO. 11-0950-01-A

ZONING

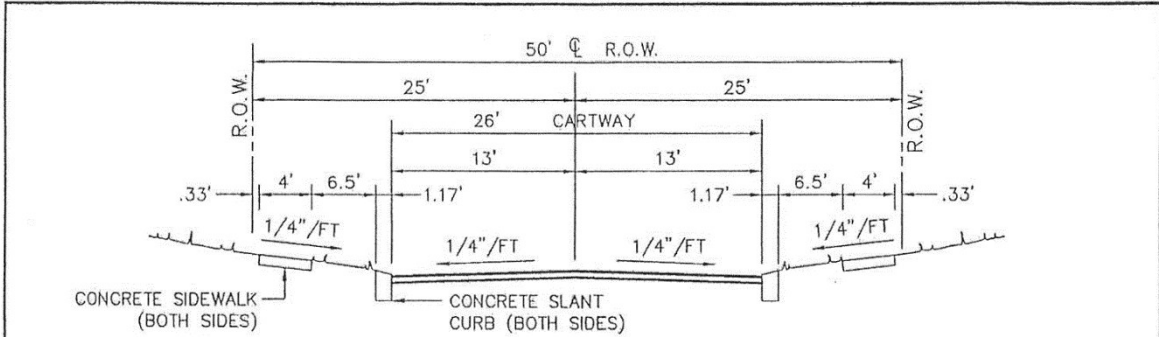

SECTION
NOT TO SCALE

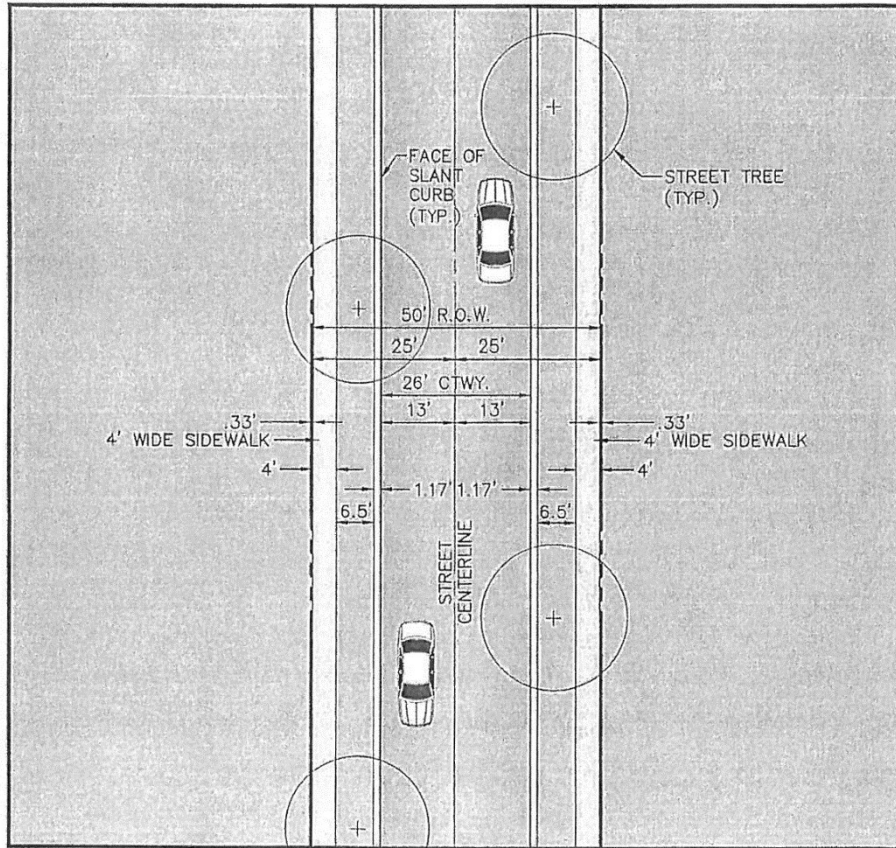

LAYOUT
NOT TO SCALE

EXHIBIT "K"

TYP. TWO-WAY LANE — NO ON-STREET
PARKING (NO HOME FRONTAGE)

FOR
MECHANICSBURG TND

MECHANICSBURG BORO CUMBERLAND COUNTY, PA

PIONEER
Management, LLC

111 Millersville Road, Lancaster, PA 17603
Phone (717) 481-5500 • Fax (717) 481-4955
Email: j@pioneermanagementllc.com
Webpage: www.pioneermanagementllc.com

DRAWN BY: DAF

DATE: APRIL 2, 2014

SCALE: NOT TO SCALE

DWG. NO. 11-0950-01-A